

**ULTRA SERIES
BOOM LIFTS**

JLG
1500S7

JLG

Distributed By:



www.onesourcerental.com

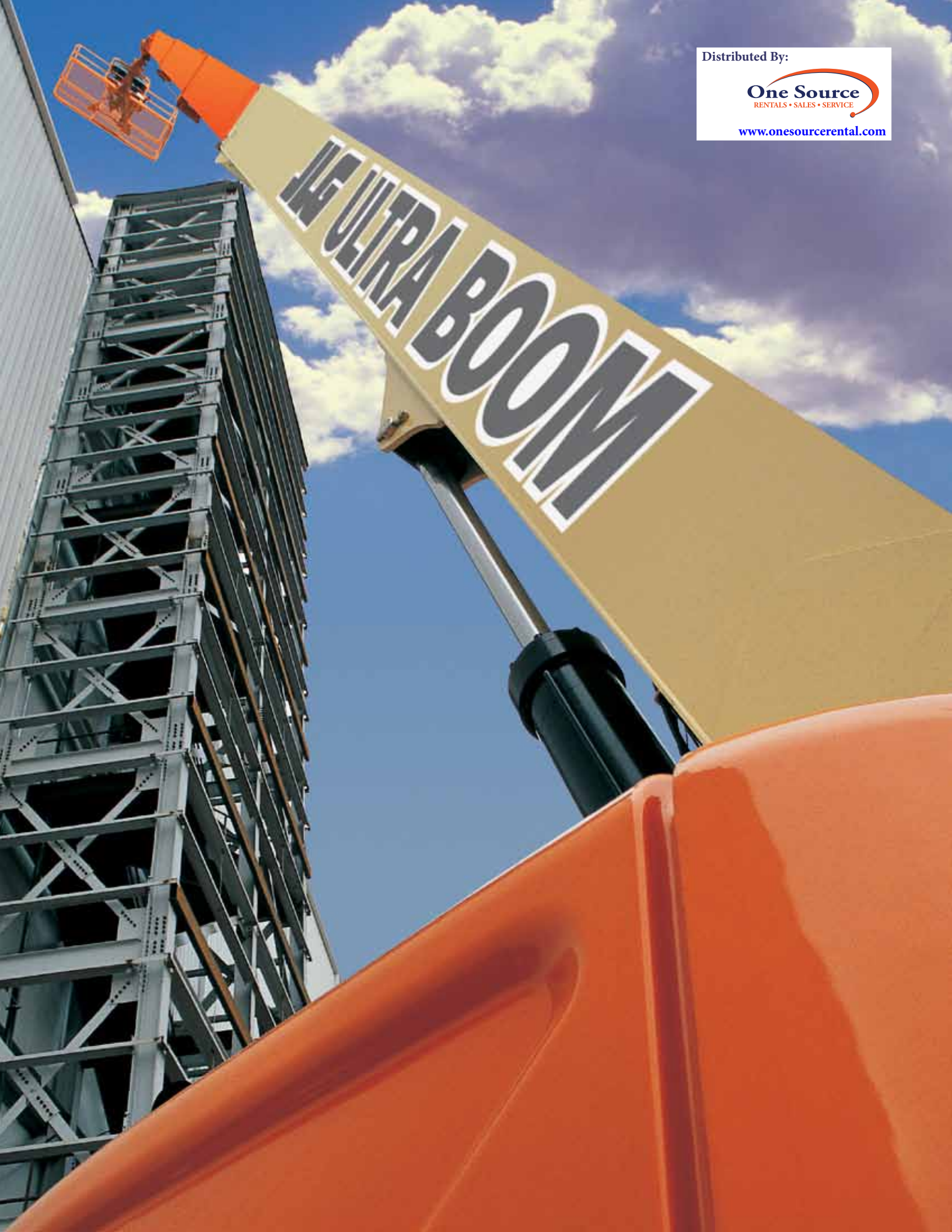

JLG® Ultra Series. Performance Unleashed.

Steel mills and chemical plants, airports, convention centers, shipyards and heavy construction. JLG® Ultra Series boom lifts are designed for rugged job sites that demand you work higher and reach farther. With four decades of experience, JLG knows the territory. You need the power, reliability and versatility to do the impossible every day. And, come back and do it again tomorrow.

JLG Ultra Series boom lifts get you there. They're built from 100,000 psi steel—40% stronger than the competition, and they'll lift up to 1,000 pounds, making them the most powerful booms in the industry.

When you're working ten stories high, you want a machine that gives you confidence to do your best work; that's built to perform and that's designed to meet any challenge—that's the JLG Ultra Series.



Ultra Series

ARTICULATING BOOM LIFTS

Unmatched Range of Motion

With up and over height of 60 ft 6 in. (18.44 m) and 63 ft 2 in. (19.25 m) of horizontal outreach, the 1250AJP gets you where you need to work.

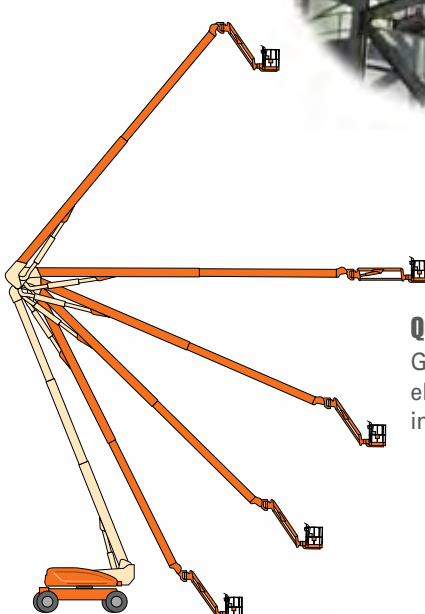

QuikStik® Advantage

Go from full platform elevation to the ground in 115 seconds.

Ultra Mobility

Go where others can't thanks to the tight turning radius, three steering modes and the only oscillating axle in its class.



Model 1250AJP

ADVANTAGES

- Optimum maneuverability with 4-wheel steer.
- Automatic platform leveling provides operator comfort at 125 ft.
- Dual capacity for more workers, tools or materials.
- Workstation in the Sky® accessories provide ultimate versatility.

The Ultimate in Height, Reach and Power.

When your job demands both height and reach, enlist Model 1250AJP. With over 60 ft of up and over height and 63 ft of outreach, the 1250AJP is ideal for applications that require high-reach versatility. The exclusive QuikStik® boom design provides faster cycle speeds—115 seconds from ground to elevation—so you can get work done quickly and efficiently. JLG Ultra Series boom lifts come with the only oscillating axle in their boom class, giving you surprising mobility in an ultra-sized package.



Distributed By:



www.onesourcerental.com

Ultra Series
TELESCOPIC BOOM LIFTS

Taking Productivity to Greater Heights.

Dominate the job site with the JLG Ultra Series. When you're facing tall challenges, you want a solid machine that goes above and beyond the day's demands. The rugged boom gives you the confidence and support you need to handle 1,000 lb capacity. The exclusive controlled arc regulates speeds at the edges of the work envelope so that you feel the same velocity in all positions for enhanced comfort.



Conquer Rough Terrain

With the tightest turning radius, best crab steer ratio and only oscillating axle in its class, you can go where other boom lifts simply can't.

Ultra Series Telescopic ADVANTAGES

- Full-time four-wheel drive gets you over rough terrain.
- SkyPower[®], a 7,500 watts on-board generator.
- Envelope tracking system regulates speeds at work envelope edges to enhance your comfort.
- JibPLUS[®] boom allows the platform to reach around corners.*

* Capacity restricted to 500 lb (227 kg) when the jib is in side-swing mode. JibPLUS for transport only for 1500SJ.



Ultra Series
TELESCOPIC BOOM LIFTS

Extend Your Reach with the 1500SJ

The Model 1500SJ is the largest self-propelled telescopic boom available from JLG—the first straight boom lift that takes you to 150 ft without an oversized load permit (over weight permit is required for highway transportation.) The 1500SJ features a telescoping jib for greater work envelope flexibility and additional outreach at elevation.

Distributed By:

One Source
RENTALS • SALES • SERVICE

www.onesourcerental.com

Ultra Series TELESCOPIC BOOM LIFTS



More Capacity

With a dual 1,000/500 lb capacity, the platform can handle more workers, tools or materials.

Larger Work Envelope

With more outreach above 50 ft, you have more access and flexibility.



Ultra Series
FEATURES

Distributed By:



www.onesourcerental.com

Oscillating Axle

Standard on all Ultra Booms, oscillating axle and full-time four-wheel drive provide superior traction.

Ultra Series
ACCESSORIES

Workstation in the Sky® Accessories.

Transform your Ultra Series boom lift into a versatile, productivity-enhancing machine with exclusive Workstation in the Sky® products. Our accessories are built to conserve platform space, improve working conditions and turn your lift into one giant work tool.

SkyPower® Package

The SkyPower system includes a self-contained 7500W continuous output generator with a power cable, and an air/water line installed in the power track. In addition, it provides self-contained 110V AC, 220V AC, and 3-phase power to run hand tools and other JLG Workstation in the Sky® accessories.

SkyWelder® Package

With a Miller® CST-280 welder tucked into the SkyPower boom platform, space is conserved while providing stick and TIG capability.

SkyCutter® Package

Eliminating the danger of draping tanks and hoses, SkyCutter cuts faster and cleaner with an on-board Miller® Spectrum 375 Cutmate plasma cutter.

SkyGlazier® Package

The first and only factory-approved glass and panel tray. Panels are protected from damage and productivity is improved while operator fatigue is reduced. And, with JLG 1,000 lb capacity, the basket can hold multiple workers and larger glass panels.



Distributed By:



www.onesourcerental.com

SkyAir® Package

With an integrated on-board air compressor, the SkyAir package delivers 9.3 CFM at pressures up to 125 psi. It increases productivity by eliminating the need for a ground-based compressor.

Nite Bright® Package

This package consists of 40-watt lights to illuminate your work site plus the area around the chassis for increased visibility. It is perfect for tunnel or mine applications, nighttime work or any job with low lighting levels.

Putting Your Work Above Everything.

When it comes to JLG® Ground Support, it's all about you. Your productivity. Your profitability. Your uptime. From the purchase of your first piece of equipment straight through to the training, parts and maintenance that follows.



Customer Service Call Center

You can be assured we'll be giving an all-out effort to support you. Just think of us as your personal on-call, full-service support team. We make it happen. Period.

Aftermarket Parts

Keep your equipment running at peak performance with genuine replacement parts, accessories, attachments, rebuilt and competitive parts all from one source—JLG.



Financial Solutions

Maximizing your profits. Preserving your cash flow. Let our financing specialists help choose the program designed specifically for your needs.



Training

Knowing your equipment inside and out results in higher productivity on the job. Our instructor-led courses give you the hands-on time you need for success.

Service Centers

Your needs. Your uptime. JLG is on the job to fulfill your every need, from repair, reconditioning, same-day parts and much more. We're here to support you.



ULTRA SERIES ARTICULATING BOOM LIFTS

SPECIFICATIONS

1250AJP

Ultra Series Articulating Boom Lifts

Reach Specifications

Platform Height	125 ft (38.1 m)
Horizontal Reach	63 ft 2 in. (19.25 m)
Up and Over Height	60 ft 6 in. (18.44 m)
Swing	360° Continuous
Platform Capacity—Restricted	1,000 lb (454 kg)
Platform Capacity—Unrestricted	500 lb (227 kg)
Platform Rotator	180°
JibPLUS®	Length
	Horizontal Motion ¹
	Vertical Motion

Dimensional Data

A. Platform Size	36 x 96 in. (0.91 x 2.44 m)
B. Overall Width	Axles Retracted
	Overall Width
	Axles Extended
C. Tailswing	3 ft (91 cm)
D. Stowed Height	10 ft (3.05 m)
E. Overall Length	Jib Stowed
	Overall Length
	Jib Deployed
F. Wheel Base	12 ft 6 in. (3.81 m)
G. Ground Clearance	Axle
	Chassis
Weight ²	44,000 lb (19,958 kg)

Chassis

Max Ground Bearing Pressure*	100 psi (7.03 kg/cm ²)
Drive Speed	3.25 mph (5.2 km/h)
Gradeability	45%
Turning Radius (Inside)	Axles Retracted
	Axles Extended
Turning Radius (Outside)	Axles Retracted
	Axles Extended
Crab Steer Ratio ³	1:1
Axle Oscillation	8 in. (20 cm)
Tires/Type	445/50D710 Foam Filled

Power Source

Diesel Engine	Deutz TD2011L4	74.9 hp (55.9 kW)
Fuel Tank Capacity	31 gal (117 L)	
Hydraulic Reservoir	53 gal (200 L)	
Auxiliary Power	12V DC	
Generator Nominal/Continuous	7,500 Watt	

- * Ground bearing pressure applies to standard tires.
 1. Capacity is limited to 500 lb (227 kg) when JibPLUS is extended horizontally.
 2. Certain options or country standards increase weight.
 3. Ratio of forward travel to lateral travel.

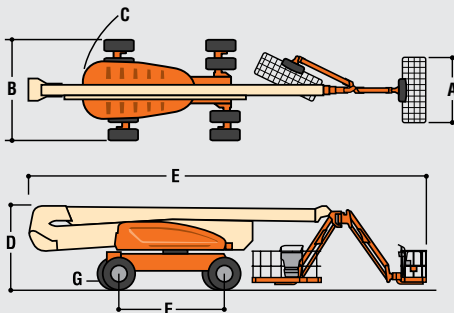

Standard Features

- Platform: 36 x 96 in. (0.91 x 2.44 m) Side Entry
- 8 ft (2.44 m) JibPLUS® Boom
- Selectable Capacity Envelope
- Inward Swinging Gate
- 180° Hydraulic Platform Rotator
- AC Receptacle in the Platform
- SkyPower® Package
 - 7500 Watt Generator
 - 240/120V Single Phase
 - 240V 3 Phase
- 1/2 in. Air Line to Platform
- 5 Degree Tilt Alarm/Indicator Light
- All Motion Alarm
- Swing-Out Engine Tray
- 12V DC Auxiliary Power
- Hourmeter
- Control ADE® System
- Full-time 4WD
- 3 Selectable Steering Modes
- Drive-out Extendible Axles
- Oscillating Axle
- Proportional Controls
- Gull-Wing Hoods
- Operator Tool Tray
- 445/50D710 Foam Filled Rim Protector Lug Tread Tires
- Platform Console Machine Status Light Panel*
- Lifting/Tie Down Lugs
- Engine Distress Warning/Shutdown—Selectable via JLG Analyzer

Available Options

- Platform: 36 x 72 in. (0.91 x 1.83 m) Side Entry
- Fall-Arrest Platform: 36 x 96 in. (0.91 x 2.44 m) Side Entry
- Light Package¹
- Flashing Beacon
- Soft-Touch System Platform
- 6 ft/8 ft (1.83 m/2.44 m)
- Clearsky (US and Canada only)
- Cold Weather Start²
- Hostile Environment Kit³
- Mesh to Top Rail
- 1. Includes platform mounted work lights and drive/backup lights.
- 2. Includes glow plugs, battery heater and oil tank heater.
- 3. Includes console cover, boom wipers and cylinder bellows.

Accessory Packages

- SkyWelder®
- SkyCutter®
- SkyGlazier®
- Nite Bright®
- Pipe Racks

* Provides indicator lights at platform control console for system distress, fuel level, low fuel, 5 degree tilt light and foot switch status.

Distributed By:



www.onesourcerental.com

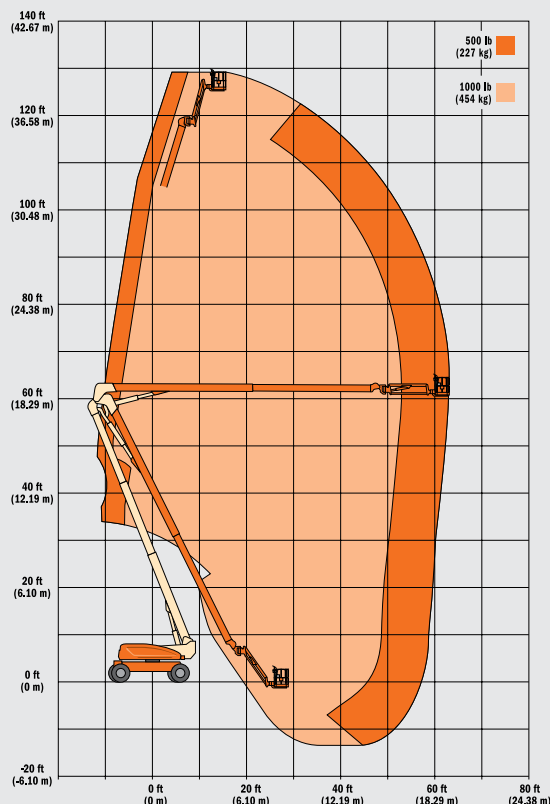

For complete specifications, visit www.jlg.com

ULTRA SERIES TELESCOPIC BOOM LIFTS SPECIFICATIONS

1200SJP

Ultra Series Telescopic Boom Lifts

Reach Specifications

Platform Height	120 ft (36.58 m)	
Horizontal Reach	75 ft (22.86 m)	
Up and Over Height	—	
Swing	360° Continuous	
Platform Capacity—Restricted	1,000 lb (454 kg)	
Platform Capacity—Unrestricted	500 lb (227 kg)	
Platform Rotator	180°	
JibPLUS®	Length	8 ft (2.44 m)
	Horizontal Motion ¹	180°
	Vertical Motion	130° (+75/-55)

Dimensional Data

A. Platform Size	36 x 96 in. (0.91 x 2.44 m)		
B. Overall Width	Axles Retracted	8 ft 2 in. (2.49 m)	
	Overall Width	Axles Extended	12 ft 6 in. (3.81 m)
C. Tailswing	5 ft 6 in. (1.67 m)		
D. Stowed Height	10 ft (3.05 m)		
E. Overall Length	Jib Stowed	37 ft 7 in. (11.45 m)	
	Overall Length	Jib Deployed	44 ft 10.25 in. (13.67 m)
F. Wheel Base	12 ft 6 in. (3.81 m)		
G. Ground Clearance	Axle	12 in. (30 cm)	
	Chassis	25.5 in. (65 cm)	
Weight ²	40,900 lb (18,552 kg)		

Chassis

Max Ground Bearing Pressure*	99 psi (7.0 kg/cm ²)	
Drive Speed	3.25 mph (5.2 km/h)	
Gradeability	45%	
Turning Radius (Inside)	Axles Retracted	14 ft 5 in. (4.39 m)
	Axles Extended	8 ft (2.44 m)
Turning Radius (Outside)	Axles Retracted	22 ft 6 in. (6.86 m)
	Axles Extended	19 ft 4 in. (5.89 m)
Crab Steer Ratio ³	1:1	
Axle Oscillation	12 in. (30 cm)	
Tires/Type	445/50D710 Foam Filled	

Power Source

Diesel Engine	Deutz TD2011L4	74.9 hp (55.9 kW)
Fuel Tank Capacity	31 gal (117 L)	
Hydraulic Reservoir	55 gal (208 L)	
Auxiliary Power	12V DC	
Generator	7500 Watt	

* Ground bearing pressure applies to standard tires.

- Capacity is limited to 500 lb (227 kg) when JibPLUS is extended horizontally.
- Certain options or country standards increase weight.
- Ratio of forward travel to lateral travel.

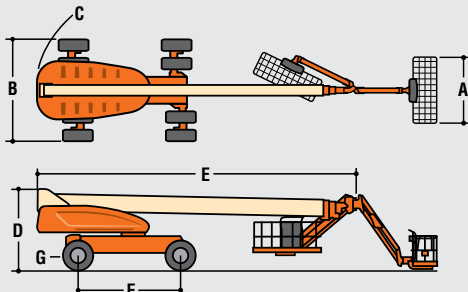

For complete specifications, visit www.jlg.com

Standard Features

Platform: 36 x 96 in. (0.91 x 2.44 m) Side Entry
8 ft (2.44 m) JibPLUS® Boom
Selectable Capacity Envelope
Inward Swinging Gate
180° Hydraulic Platform Rotator
AC Receptacle in the Platform
SkyPower® Package
7500 Watt Generator
• 240/120V Single Phase
• 240V 3 Phase
1/2 in. Air Line to Platform
5 Degree Tilt Alarm/Indicator Light
All Motion Alarm
Swing-Out Engine Tray
12V DC Auxiliary Power
Hourmeter
Control ADE® System
Full-time 4WD
3 Selectable Steering Modes
Drive-out Extendible Axles
Oscillating Axle
Proportional Controls
Gull-Wing Hoods
Operator Tool Tray
445/50D710 Foam Filled Rim Protector Lug Tread Tires
Platform Console Machine Status Light Panel*
Lifting/Tie Down Lugs
Engine Distress Warning/Shutdown—Selectable via JLG Analyzer

Available Options

Platform: 36 x 72 in. (0.91 x 1.83 m) Side Entry
Fall-Arrest Platform: 36 x 96 in. (0.91 x 2.44 m) Side Entry
Light Package¹
Flashing Beacon
Soft-Touch System Platform
6 ft/8 ft (1.83 m/2.44 m)
Clearsky (US and Canada only)
Cold Weather Start²
Hostile Environment Kit³
Mesh to Top Rail
1. Includes platform mounted work lights and drive/backup lights.
2. Includes glow plugs, battery heater and oil tank heater.
3. Includes console cover, boom wipers and cylinder bellows.

Accessory Packages

SkyWelder®
SkyCutter®
SkyAir® (1200/1350SJP only)
SkyGlazier®
Nite Bright®
Pipe Racks

* Provides indicator lights at platform control console for system distress, fuel level, low fuel, 5 degree tilt light and foot switch status.

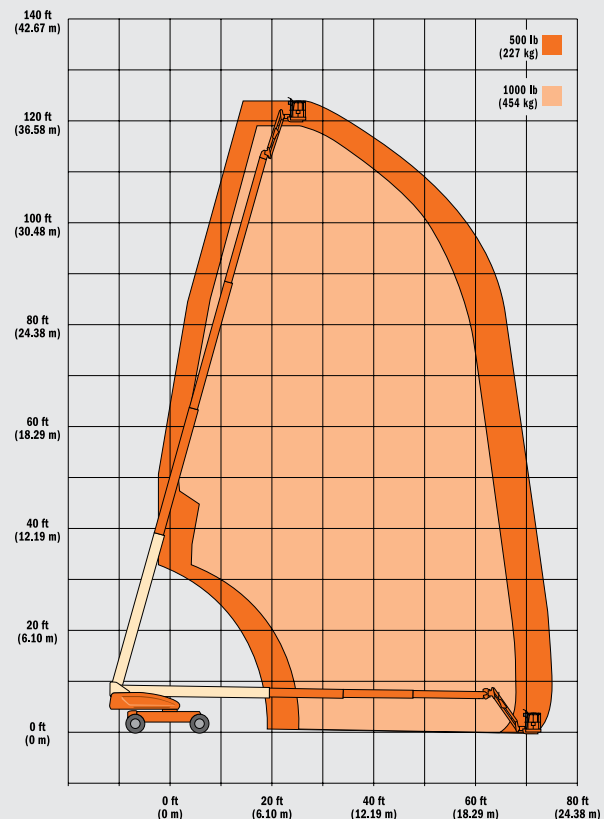

ULTRA SERIES TELESCOPIC BOOM LIFTS

SPECIFICATIONS

1350SJ

Ultra Series Telescopic Boom Lifts

Reach Specifications

Platform Height	135 ft (41.15 m)	
Horizontal Reach	80 ft (24.38 m)	
Up and Over Height	—	
Swing	360° Continuous	
Platform Capacity—Restricted	1,000 lb (454 kg)	
Platform Capacity—Unrestricted	500 lb (227 kg)	
Platform Rotator	180°	
JibPLUS®	Length	8 ft (2.44 m)
	Horizontal Motion ¹	180°
	Vertical Motion	130° (+75/-55)

Dimensional Data

A. Platform Size	36 x 96 in. (0.91 x 2.44 m)	
B. Overall Width	Axles Retracted	8 ft 2 in. (2.49 m)
	Axles Extended	12 ft 6 in. (3.81 m)
C. Tailswing	5 ft 6 in. (1.67 m)	
D. Stowed Height	10 ft (3.05 m)	
E. Overall Length	Jib Stowed	37 ft 7 in. (11.45 m)
	Jib Deployed	48 ft 10.25 in. (14.89 m)
F. Wheel Base	Axle	12 ft 6 in. (3.81 m)
	Chassis	25.5 in. (65 cm)
G. Ground Clearance	Axle	12 in. (30 cm)
	Chassis	25.5 in. (65 cm)
Weight ²	45,000 lb (20,411 kg)	

Chassis

Max Ground Bearing Pressure*	107 psi (7.52 kg/cm ²)	
Drive Speed	3.25 mph (5.2 km/h)	
Gradeability	45%	
Turning Radius (Inside)	Axles Retracted	14 ft 5 in. (4.39 m)
	Axles Extended	8 ft (2.44 m)
Turning Radius (Outside)	Axles Retracted	22 ft 6 in. (6.86 m)
	Axles Extended	19 ft 4 in. (5.89 m)
Crab Steer Ratio ³	1:1	
Axle Oscillation	12 in. (30 cm)	
Tires/Type	445/50D710 Foam Filled	

Power Source

Diesel Engine	Deutz TD2011L4	74.9 hp (55.9 kW)
Fuel Tank Capacity		31 gal (117 L)
Hydraulic Reservoir		55 gal (208 L)
Auxiliary Power		12V DC
Generator Nominal/Continuous		7,500 Watt

* Ground bearing pressure applies to standard tires.

1. Capacity is limited to 500 lb (227 kg) when JibPLUS is extended horizontally.

2. Certain options or country standards increase weight.

3. Ratio of forward travel to lateral travel.

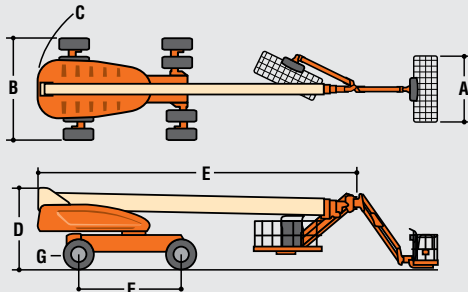

Standard Features

Platform: 36 x 96 in. (0.91 x 2.44 m) Side Entry
 8 ft (2.44 m) JibPLUS® Boom
 Selectable Capacity Envelope
 Inward Swinging Gate
 180° Hydraulic Platform Rotator
 AC Receptacle in the Platform
 SkyPower® Package
 7500 Watt Generator
 • 240/120V Single Phase
 • 240V 3 Phase
 1/2 in. Air Line to Platform
 5 Degree Tilt Alarm/Indicator Light
 All Motion Alarm
 Swing-Out Engine Tray
 12V DC Auxiliary Power
 Hourmeter
 Control ADE® System
 Full-time 4WD
 3 Selectable Steering Modes
 Drive-out Extendible Axles
 Oscillating Axle
 Proportional Controls
 Gull-Wing Hoods
 Operator Tool Tray
 445/50D710 Foam Filled Rim Protector Lug Tread Tires
 Platform Console Machine Status Light Panel*
 Lifting/Tie Down Lugs
 Engine Distress Warning/Shutdown—Selectable via JLG Analyzer

Available Options

Platform: 36 x 72 in. (0.91 x 1.83 m) Side Entry
 Fall-Arrest Platform: 36 x 96 in. (0.91 x 2.44 m) Side Entry
 Light Package¹
 Flashing Beacon
 Soft-Touch System Platform
 6 ft/8 ft (1.83 m/2.44 m)
 Clearsky (US and Canada only)
 Cold Weather Start²
 Hostile Environment Kit³
 Mesh to Top Rail

1. Includes platform mounted work lights and drive/backup lights.
2. Includes glow plugs, battery heater and oil tank heater.
3. Includes console cover, boom wipers and cylinder bellows.

Accessory Packages

SkyWelder®
 SkyCutter®
 SkyAir® (1200/1350SJ only)
 SkyGlazier®
 Nite Bright®
 Pipe Racks

* Provides indicator lights at platform control console for system distress, fuel level, low fuel, 5 degree tilt light and foot switch status.

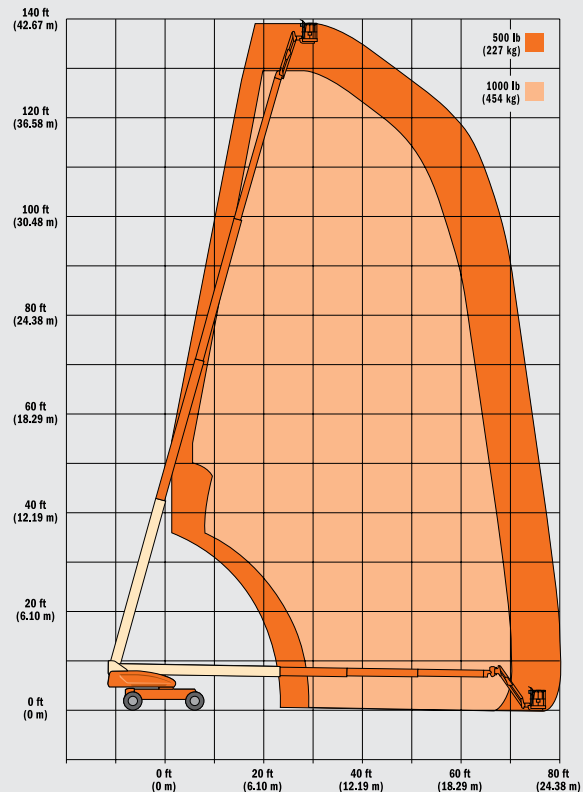

ULTRA SERIES TELESCOPIC BOOM LIFTS SPECIFICATIONS

1500SJ

Ultra Series Telescopic Boom Lifts

Reach Specifications

Platform Height	150 ft (45.7 m)	
Horizontal Reach	80 ft (24.38 m)	
Up and Over Height	—	
Swing	360° Continuous	
Platform Capacity—Restricted	1,000 lb (454 kg)	
Platform Capacity—Unrestricted	500 lb (227 kg)	
Platform Rotator	180°	
Jib	Length	15 ft 2 in.—25 ft (4.62 m—7.62 m)
	Horizontal Motion ¹	For Transport Only
	Vertical Motion	120° (+75/-45)

Dimensional Data

A. Platform Size	36 x 96 in. (0.91 x 2.44 m)	
B. Overall Width	Axles Retracted	8 ft 2 in. (2.49 m)
	Axles Extended	12 ft 6 in. (3.81 m)
C. Tailswing	5 ft 6 in. (1.67 m)	
D. Stowed Height	10 ft (3.05 m)	
E. Overall Length	Jib Stowed	43 ft (11.45 m)
	Jib Deployed	61 ft 9 in. (18.82 m)
F. Wheel Base	12 ft 6 in. (3.81 m)	
G. Ground Clearance	Axle	12 in. (30 cm)
	Chassis	25.5 in. (65 cm)
Weight ²	48,000 lb (21,773 kg)	

Chassis

Max Ground Bearing Pressure*	113 psi (7.94 kg/cm ²)	
Drive Speed	3.0 mph (4.8 km/h)	
Gradeability	40%	
Turning Radius (Inside)	Axles Retracted	14 ft 5 in. (4.39 m)
	Axles Extended	8 ft (2.44 m)
Turning Radius (Outside)	Axles Retracted	22 ft 6 in. (6.86 m)
	Axles Extended	19 ft 4 in. (5.89 m)
Crab Steer Ratio ³	1:1	
Axle Oscillation	12 in. (30 cm)	
Tires/Type	445/50D710 Foam Filled	

Power Source

Diesel Engine	Deutz TD2011L04	74.9 hp (55.9 kW)
Fuel Tank Capacity	31 gal (117 L)	
Hydraulic Reservoir	55 gal (208 L)	
Auxiliary Power	12V DC	
Generator	7,500 Watt	

* Ground bearing pressure applies to standard tires.

1. Capacity is limited to 500 lb (227 kg) when Jib is extended.

2. Certain options or country standards increase weight.

3. Ratio of forward travel to lateral travel.

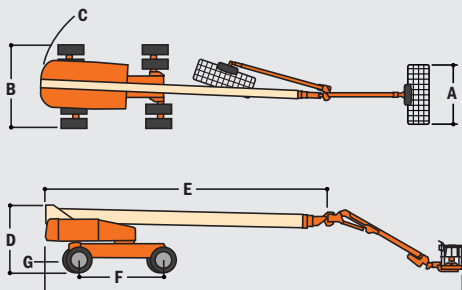

For complete specifications, visit www.jlg.com

Standard Features

Platform: 36 x 96 in. (0.91 x 2.44 m) Side Entry
 8 ft (2.44 m) JibPLUS® Boom
 Selectable Capacity Envelope
 Inward Swinging Gate
 180° Hydraulic Platform Rotator
 AC Receptacle in the Platform
 SkyPower® Package
 7500 Watt Generator
 • 240/120V Single Phase
 • 240V 3 Phase
 1/2 in. Air Line to Platform
 5 Degree Tilt Alarm/Indicator Light
 All Motion Alarm
 Swing-Out Engine Tray
 12V DC Auxiliary Power
 Hourmeter
 Control ADE® System
 Full-time 4WD
 3 Selectable Steering Modes
 Drive-out Extendible Axles
 Oscillating Axle
 Proportional Controls
 Gull-Wing Hoods
 Operator Tool Tray
 445/50D710 Foam Filled Rim Protector Lug Tread Tires
 Platform Console Machine Status Light Panel*
 Lifting/Tie Down Lugs
 Engine Distress Warning/Shutdown—Selectable via JLG Analyzer

Available Options

Platform: 36 x 72 in. (0.91 x 1.83 m) Side Entry
 Fall-Arrest Platform: 36 x 96 in. (0.91 x 2.44 m) Side Entry
 Light Package¹
 Flashing Beacon
 Soft-Touch System Platform
 6 ft/8 ft (1.83 m/2.44 m)
 Clearsky (US and Canada only)
 Cold Weather Start²
 Hostile Environment Kit³
 Mesh to Top Rail
 1. Includes platform mounted work lights and drive/backup lights.
 2. Includes glow plugs, battery heater and oil tank heater.
 3. Includes console cover, boom wipers and cylinder bellows.

Accessory Packages

SkyWelder®
 SkyCutter®
 SkyAir® (1200/1350SJ only)
 SkyGlazier®
 Nite Bright®
 Pipe Racks

* Provides indicator lights at platform control console for system distress, fuel level, low fuel, 5 degree tilt light and foot switch status.

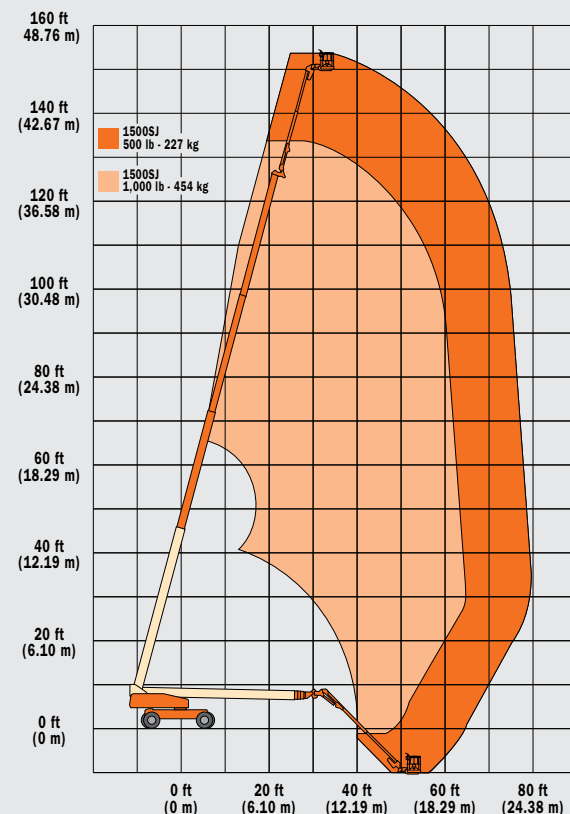

JLG Industries, Inc.
1 JLG Drive
McConnellsburg, PA 17233-9533
Telephone 717-485-5161
Toll-free in US 877-JLG-LIFT
Fax 717-485-6417
www.jlg.com
An Oshkosh Corporation Company

Form No.: UB-BRO-0208
Part No.: 3131561
R041103
Printed in USA

